



The Oventrop Quality Management System is certified to DIN-EN-ISO 9001

Tender specification (examples):

Oventrop brass connection fittings, nickel plated for the connection of radiators with integrated distributor 3/4" male thread according to DIN V 3838 (cone "Euro").

ZB preset isolating fitting for two pipe systems for filling and draining

3/4" (3/4" collar nut x 3/4" male thread)

Oventrop brass connection fittings, nickel plated for the connection of radiators with integrated distributor 1/2" female thread.

ZB preset isolating fitting for two pipe systems for filling and draining

1/2" (1/2" male thread x 3/4" male thread)

Working temperature t_s : 2°C up to 120°C (for short periods up to 130°C)

Max. working pressure p_s : 10 bar

Function:

The Oventrop connection programme "Multiflex" for the connection of radiators with integrated distributor.

The extensive programme fulfils the following functions:

- connecting
- isolating
- one pipe operation
- draining
- filling
- presetting
- re-directing
- bridging

Application:

The Oventrop connection programme "Multiflex" for radiators with integrated distributor is suitable for two or one pipe heating systems.

For use of the radiators with integrated distributor in one pipe systems, special ZBU fittings (two pipe block, transformable) are available. In addition, Oventrop offers inversion fittings to achieve the correct direction of flow if supply and return pipe were mixed up and bridging fittings to fix the pipework and to bridge over the supply and return pipe in case of subsequent installation of radiators.

"Multiflex F" with soft seal

The connection fittings to the radiator are self sealing. (The self sealing nipples are supplied with every fitting for radiators with 1/2" female thread.)

Advantages of the connection programme "Multiflex F":

- all connection problems of radiators with integrated distributor can be solved
- easy to use
- suitable for one and two pipe systems (ZBU)
- increased leakage proofing due to soft sealing connection
- exact setting of the radiator shares via the bypass screw (ZBU)
- excellent flow rates of the ZBU fittings when used with the Oventrop thermostats with 2 K P-deviation (see flow chart)



"Multiflex V" metal to metal sealing

The connection fittings have a metal to metal seal to the radiator.

Advantages of the connection programme "Multiflex V":

- all connection problems of radiators with integrated distributor can be solved
- connection fittings with facilities to isolate
preset
drain
fill
- easy to use
- suitable for one and two pipe systems
- tolerances in the connection dimensions of the supply and return nipples are technically perfectly balanced (patented solution). This means that there is no cross tension (see illustration)
- increased leakage proofing due to metal to metal sealing connection to the radiator
- no inner parts necessary to take elastic seals, therefore two points less where leakage could occur
- technical top performance regarding flow rates
- exact setting of radiator shares via the bypass screw in lengthwise direction (CE fitting)

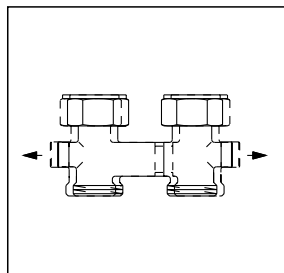

Advantage:
Adjustable distance of axis

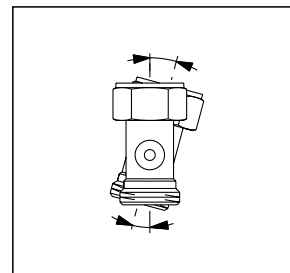

Advantage:
Adjustable angled position

**Connection programme "Multiflex V"
with metal to metal seal
for two pipe heating systems:**

Brass connection fittings, nickel plated
for radiators with integrated distributor

ZB fittings (ZB = two pipe block)

The ZB fittings (two pipe block) are used on radiators with two pipe distributors.

Balanced tolerance of the radiator connection due to patented body/shell connection.

Distance between pipe centres 50 mm.

3/4" male thread (distributor)

The connection fittings have a metal to metal seal to the radiator.

1/2" female thread (distributor)

The connection fittings to the radiator are self sealing. Self sealing nipples are supplied with every fitting.

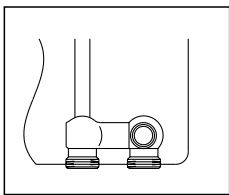

For radiators with 3/4" male thread according to DIN V 3838 (cone "Euro")

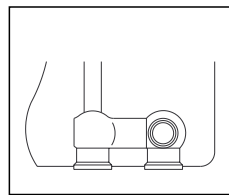

For radiators with 1/2" female thread

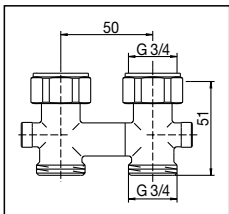

ZB isolating fitting
3/4" (3/4" collar nut x
3/4" male thread)
Item no. 101 62 11

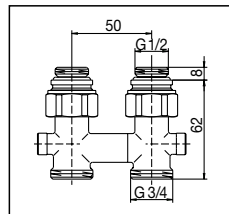

ZB isolating fitting
1/2" (1/2" x 3/4" all male
thread)
Item no. 101 62 81

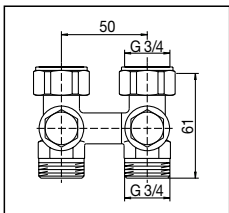

ZB preset isolating
fitting for filling and
draining
3/4" (3/4" collar nut x
3/4" male thread)
Item no. 101 62 41

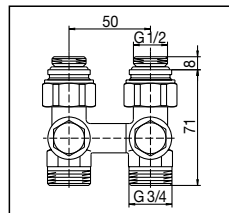

ZB preset isolating
fitting for filling and
draining
1/2" (1/2" x 3/4" all male
thread)
Item no. 101 62 91

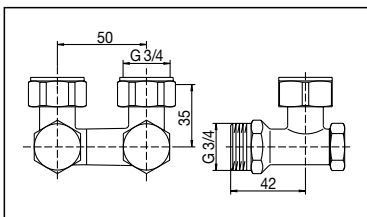

ZB angle pattern pre-
set isolating fitting
3/4" (3/4" collar nut x
3/4" male thread)
Item no. 101 62 12

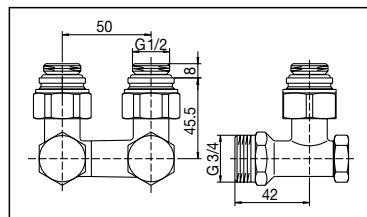

ZB angle pattern
preset isolating fitting
1/2" (1/2" x 3/4" all male
thread)
Item no. 101 62 82

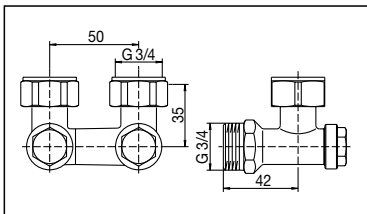

ZB angle pattern
preset isolating fitting
for filling and draining
3/4" (3/4" collar nut x
3/4" male thread)
Item no. 101 62 42

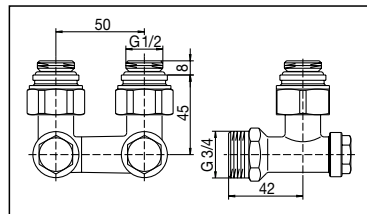

ZB angle pattern
preset isolating fitting
for filling and draining
1/2" (1/2" x 3/4" all male
thread)
Item no. 101 62 92

**Connection programme "Multiflex V"
with metal to metal seal
for two pipe systems:**

Brass connection fittings, nickel plated
for radiators with integrated distributor

Single fittings

Item no. per piece.

The single fittings are used on radiators with two pipe distributor.

3/4" male thread (distributor)

The connection fittings have a metal to metal seal to the radiator.

1/2" female thread (distributor)

The connection fittings to the radiator are self sealing. Self sealing nipples are supplied with each fitting.

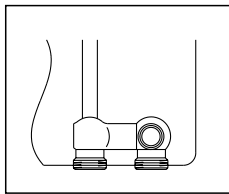

For radiators with 3/4" male thread according to DIN V 3838 (cone "Euro")

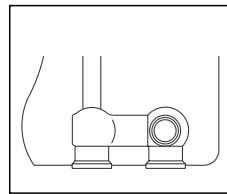

For radiators with 1/2" female thread

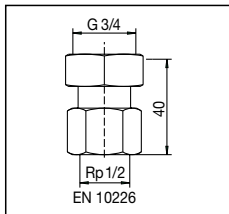

Connection fitting
3/4" (3/4" collar nut x 1/2" female thread)
Item no. 101 63 04

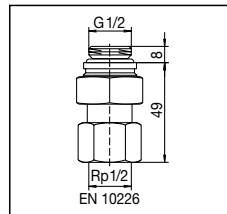

Connection fitting
1/2" (1/2" male thread x 1/2" female thread)
Item no. 101 63 84

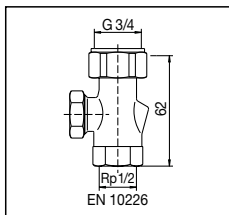

Isolating fitting "Combi 2"*
3/4" (3/4" collar nut x 1/2" female thread)
Item no. 101 61 04
3/4" (3/4" collar nut x 3/4" male thread)
Item no. 101 61 06

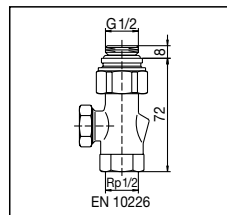

Isolating fitting "Combi 2"*
1/2" (1/2" x 3/4" all male thread)
Item no. 101 61 86

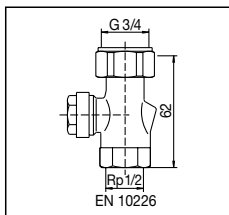

Isolating fitting "Combi 3"*
3/4" (3/4" collar nut x 1/2" female thread)
Item no. 101 61 65
3/4" (3/4" collar nut x 3/4" male thread)
Item no. 101 61 55

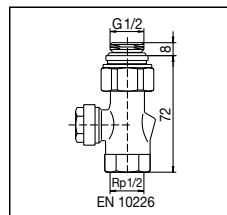

Isolating fitting "Combi 3"*
1/2" (1/2" x 3/4" all male thread)
Item no. 101 61 76

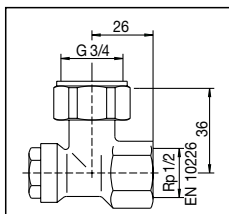

Angle pattern isolating fitting "Combi 3"*
3/4" (3/4" collar nut x 3/4" male thread)
Item no. 101 65 55

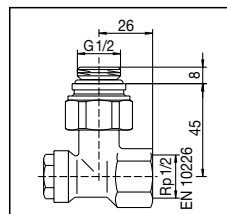

Angle pattern isolating fitting "Combi 3"*
1/2" (1/2" male thread x 1/2" female thread)
Item no. 101 65 74
1/2" (1/2" x 3/4" all male thread)
Item no. 101 65 76

Fittings with 1/2" female thread are not suitable for compression fittings (only for threaded pipes). Use Oventrop compression fittings on page 1.52 of the general catalogue "Products".

* "Combi 2" for isolating and presetting, * "Combi 3" for isolating, presetting, filling and draining

**Connection programme "Multiflex V"
with metal to metal seal
for one pipe heating systems:**

Brass connection fittings, nickel plated
for radiators with integrated distributor.

CE fittings (Combi one pipe)

Distance between pipe centres 50 mm.

The CE fittings (Combi one pipe) are necessary to use radiators with two pipe distributors in **one pipe systems**.

Preset radiator flow share: about 35%*.

Balanced tolerance of the radiator connection due to patented body/shell connection

3/4" male thread (distributor)

The connection fittings have a metal to metal seal to the radiator.

1/2" female thread (distributor)

The connection fittings to the radiator are self sealing. Self sealing nipples are supplied with every fitting.

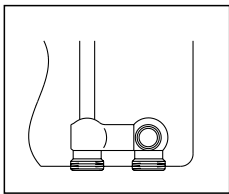

For radiators with 3/4" male thread according to DIN V 3838 (cone "Euro")

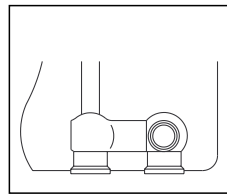

For radiators with 1/2" female thread

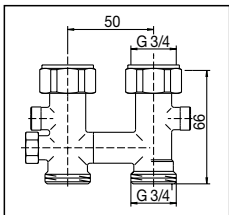

CE isolating fitting
3/4" (3/4" collar nut x
3/4" male thread)
Item no. 101 63 11

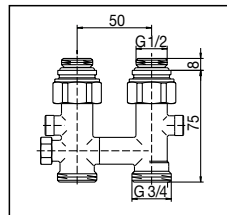

CE isolating fitting
1/2" (1/2" x 3/4" all male
thread)
Item no. 101 63 81

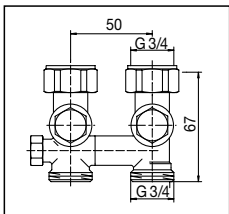

CE preset isolating
fitting for filling and
draining
3/4" (3/4" collar nut x
3/4" male thread)
Item no. 101 63 41

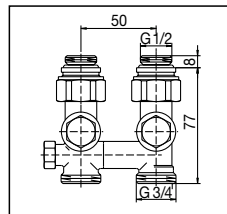

CE preset isolating
fitting for filling and
draining
1/2" (1/2" x 3/4" all male
thread)
Item no. 101 63 91

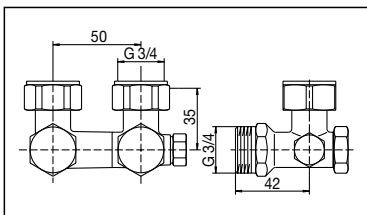

CE angle pattern
preset isolating fitting
3/4" (3/4" collar nut x
3/4" male thread)
Item no. 101 63 12

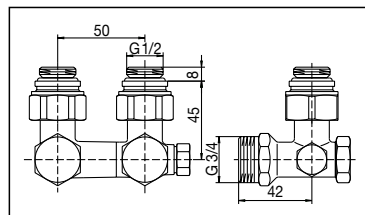

CE angle pattern
preset isolating fitting
1/2" (1/2" x 3/4" all male
thread)
Item no. 101 63 82

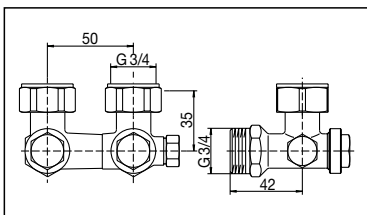

CE angle pattern
preset isolating fitting
for filling and draining
3/4" (3/4" collar nut x
3/4" male thread)
Item no. 101 63 42

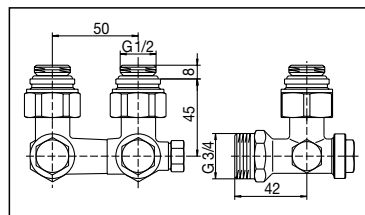

CE angle pattern
preset isolating fitting
for filling and draining
1/2" (1/2" x 3/4" all male
thread)
Item no. 101 63 92

* If the bypass screw is turned clockwise until stop, then the bypass is closed (two pipe operation).

Connection programme "Multiflex F" with soft seal for one pipe systems or heating systems in one pipe operation:

Brass connection fittings, nickel plated for radiators with integrated distributor

ZB fittings (two pipe block)

The ZB fittings (two pipe block) are used on radiators with two pipe distributors.

3/4" male thread (distributor)

The connection fittings to the radiator have a soft seal.

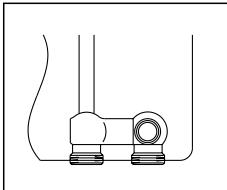

For radiators with 3/4" male thread according to DIN V 3838 (cone "Euro")

1/2" female thread (distributor)

The connection fittings to the radiator are self sealing. Self sealing nipples are supplied with every fitting.

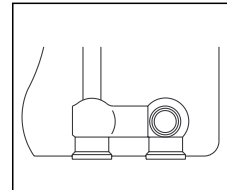

For radiators with 1/2" female thread

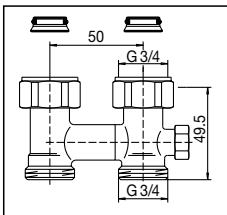

CE fitting preset to one pipe 3/4" (3/4" collar nut x 3/4" male thread)
Item no. 101 58 10

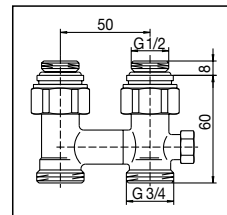

CE fitting preset to one pipe 1/2" (1/2" x 3/4" all male thread)
Item no. 101 58 80

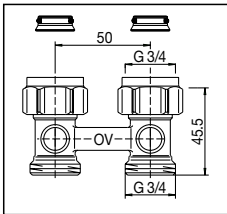

ZB isolating fitting 3/4" (3/4" collar nut x 3/4" male thread)
Item no. 101 58 13

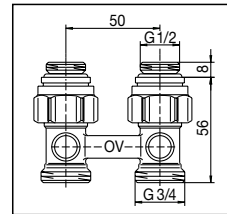

ZB isolating fitting 1/2" (1/2" x 3/4" all male thread)
Item no. 101 58 83

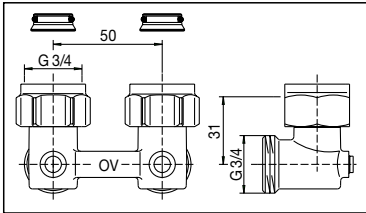

ZB angle pattern preset isolating fitting 3/4" (3/4" collar nut x 3/4" male thread)
Item no. 101 58 14

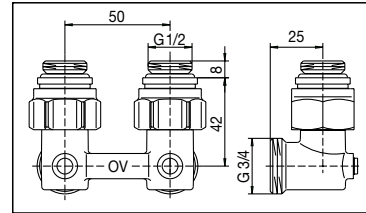

ZB angle pattern isolating fitting 1/2" (1/2" x 3/4" all male thread)
Item no. 101 58 84

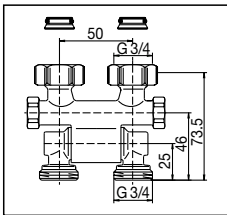

ZB isolating fitting, swivelling 3/4" (3/4" collar nut x 3/4" male thread)
Item no. 101 57 11

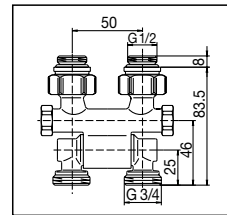

ZB isolating fitting, swivelling 1/2" (1/2" x 3/4" all male thread)
Item no. 101 57 81

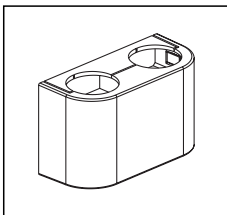

Design cover, white for ZB isolating and angle pattern fittings,
item nos. 101 58 13/14/83/84
Item no. 101 58 96

Connection programme "Multiflex F" with soft seal for two pipe systems or heating systems in one pipe operation:

Brass connection fittings, nickel plated for radiators with integrated distributor

ZBU fittings (two pipe block, transformable)

The ZBU fittings (two pipe block, transformable) can be used in both, two pipe systems (as delivered) or in systems with one pipe operation.

When used in one pipe systems, the bypass screw has to be set according to the installation instructions delivered with the fittings. CEW fitting as ZBU, but preset to one pipe operation with a radiator share of 35%

Distance between pipe centres 50 mm.

3/4" male thread (distributor)

The connection fittings to the radiator have a soft seal.

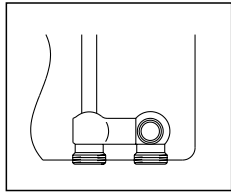

For radiators with 3/4" male thread according to DIN V 3838 (cone "Euro")

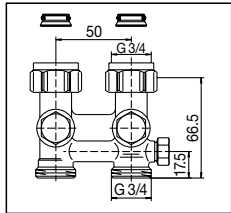

ZBU-CEW preset isolating fitting for filling and draining
3/4" (3/4" collar nut x 3/4" male thread)
Item no. 101 59 43
Item no. 101 59 23*

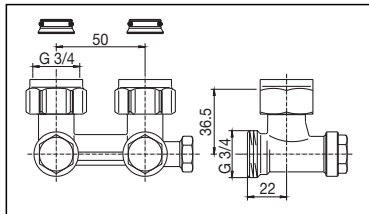

ZBU-CEW angle pattern preset isolating fitting for filling and draining
3/4" (3/4" collar nut x 3/4" male thread)
Item no. 101 59 44
Item no. 101 59 24*

*preset to one pipe operation

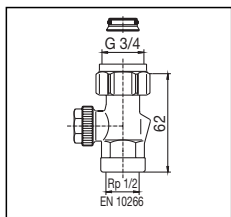

Isolating fitting "Combi 3"
3/4" (3/4" collar nut x 1/2" female thread)
Item no. 101 61 66
3/4" (3/4" collar nut x 3/4" male thread)
Item no. 101 61 68

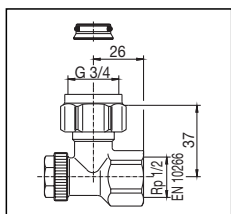

Angle pattern isolating fitting "Combi 3"
3/4" (3/4" collar nut x 1/2" female thread)
Item no. 101 65 67
3/4" (3/4" collar nut x 3/4" male thread)
Item no. 101 65 69

Single fittings

Item no. per piece.

The single fittings are used on radiators with two pipe distributor.

1/2" female thread (distributor)

The connection fittings to the radiator are self sealing. Self sealing nipples are supplied with every fitting.

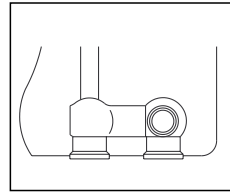

For radiators with 1/2" female thread

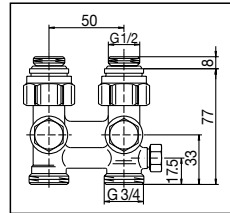

ZBU-CEW preset isolating fitting for filling and draining
1/2" (1/2" x 3/4" all male thread)
Item no. 101 59 93
Item no. 101 59 33*

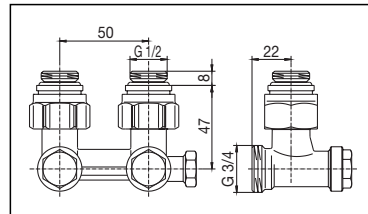

ZBU angle pattern preset isolating fitting for filling and draining
1/2" (1/2" x 3/4" all male thread)
Item no. 101 59 94
Item no. 101 59 34*

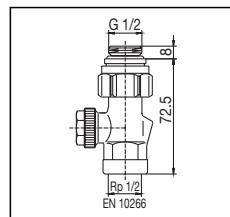

Isolating fitting "Combi 3"
1/2" (1/2" male thread x 1/2" female thread)
Item no. 101 61 75
1/2" (1/2" male thread x 3/4" male thread)
Item no. 101 61 77

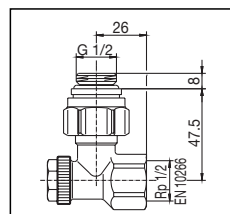

Angle pattern isolating fitting "Combi 3"
1/2" (1/2" male thread x 1/2" female thread)
Item no. 101 65 75
1/2" (1/2" male thread x 3/4" male thread)
Item no. 101 65 77

Fittings with 1/2" female thread are not suitable for compression fittings (only for threaded pipes). Use Oventrop compression fittings on page 1.52 of the general catalogue "Products".

** "Combi 3" for isolating, presetting, filling and draining

Fittings

brass

Inversion fitting, nickel plated

For reversed supply and return pipe.

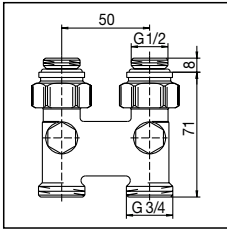

with isolating facility
distance between pipe
centres 50 mm
1/2" x 3/4" all male thread
Item no. 101 63 63

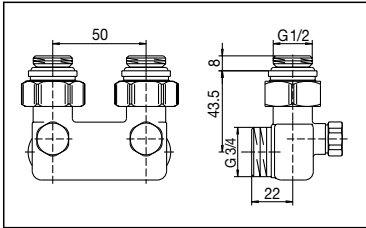

angle pattern,
with isolating facility
distance between pipe
centres 50 mm
1/2" x 3/4" all male thread
Item no. 101 64 63

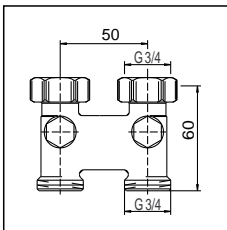

with isolating facility
distance between pipe
centres 50 mm
3/4" collar nut x 3/4"
male thread
Item no. 101 63 62

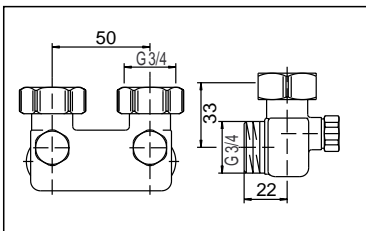

angle pattern,
with isolating facility
distance between pipe
centres 50 mm
3/4" collar nut x 3/4"
male thread
Item no. 101 64 62

Bridging fitting

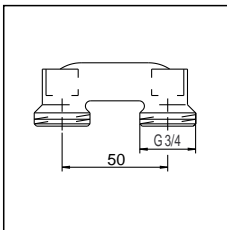

for bridging over the
supply and the return
pipe in case of subse-
quent installation of
radiators.
Distance between
pipe centres 50 mm
Item no. 101 64 52

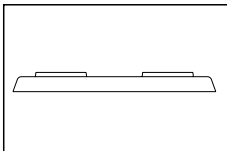

Plastic rosette cover

flat, distance between
pipe centres 50 mm
Perforation

12 mm	101 66 71
14 mm	101 66 72
15 mm	101 66 73
16 mm	101 66 74
18 mm	101 66 75

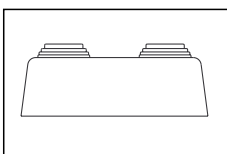

for pipe dimensions 10, 12, 15, 16,
18, 20 mm
Distance between
pipe centres 50 mm 101 66 62
Distance between
pipe centres 45 mm 101 66 61

Connection fittings

brass

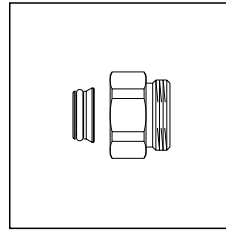

Distance piece
for fittings "Multiflex" delivered as
set = 2 pieces
3/4" female thread x 3/4" male
thread
Effective length: 15.5 mm
Item no. 168 16 50

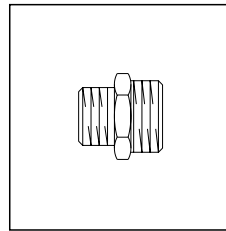

Nipple, unplated
3/8" x 3/4" all male thread
port 3/8" with tapered sealing ac-
cording to DIN V 3838 (cone "Euro")
Item no. 102 80 51
1/2" x 3/4" all male thread
port 3/4" with tapered sealing ac-
cording to DIN V 3838 (cone "Euro")
Item no. 102 80 52

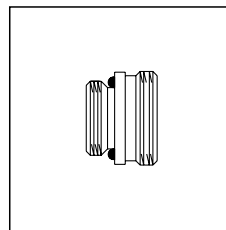

Nipple, unplated
one port: self sealing
for "Multiflex F",
port 3/4" flat sealing
1/2" x 3/4" all male thread
Item no. 102 82 52
for "Multiflex V",
port 3/4" with tapered sealing ac-
cording to DIN V 3838 (cone "Euro")
1/2" x 3/4" all male thread
Item no. 102 82 53

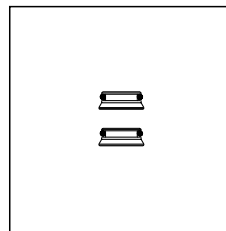

Insert as set = 2 pieces
with cone
for fittings "Multiflex F"
Item no. 166 11 00

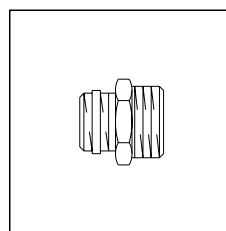

Nipple, nickel plated
one port self sealing
1/2" x 3/4" all male thread
port 3/4" with tapered sealing ac-
cording to DIN V 3838 (cone "Euro")
Item no. 102 81 61

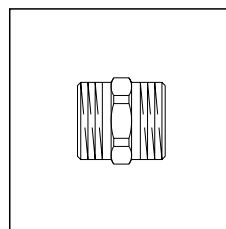

Double nipple, nickel plated
3/4" x 3/4" all male thread
port 3/4" with tapered sealing ac-
cording to DIN V 3838 (cone "Euro")
Item no. 102 82 63

Connection fittings

Brass fittings, nickel plated
for radiators with integrated distributor

Special applications:

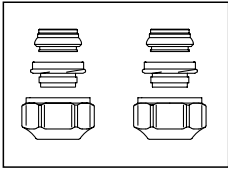

Compression fittings
"Ofix CEP" - "Snap & Seal"
2-fold for copper pipes according to DIN EN 1057, precision steel pipes according to DIN EN 10305-1/2 and stainless steel pipes, collar nut nickel plated, with double function, soft sealing, 95°C max.
10 mm 101 68 40
12 mm 101 68 41
14 mm 101 68 42
15 mm 101 68 43
16 mm 101 68 44
18 mm 101 68 45

Attention: When installing copper pipes with a wall thickness of ≤ 1 mm, it is necessary to use reinforcing sleeves for the additional stabilisation of the pipe. Should the wall thickness exceed 1 mm, please contact the pipe manufacturer. Reinforcing sleeves for wall thickness = 1 mm: see catalogue "Products", page 1.53
Exception:
Reinforcing sleeves are not required for soft sealing compression fittings.
Note: The pipes are not held by the soft sealing fitting, they have to be fixed additionally. Regarding stretching of the pipe ends, the instructions of the pipe manufacturers have to be observed.

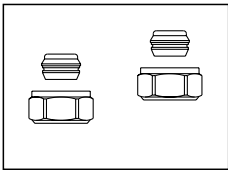

"Ofix CEP"
2-fold for copper pipes according to DIN EN 1057
collar nut nickel plated,
metal to metal sealing
10 mm 101 68 60
12 mm 101 68 61
14 mm 101 68 62
15 mm 101 68 63
16 mm 101 68 64
18 mm 101 68 65

Mineral oils, including thread cutting oils/greases, will have an adverse effect on any EPDM components, such as valve seals, pump seals and flexible connections, in a pipework system. Therefore it is essential that pipework systems are thoroughly cleaned of any residues, and that the use of water treatments containing mineral oils is avoided.

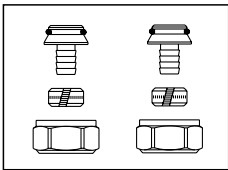

„Ofix K“
2-fold for plastic pipes according to DIN 4726, PE-X according to DIN 16892/16893, PB according to DIN 16968, PP according to DIN 8078 A1, collar nut nickel plated, metal to metal sealing plus O-ring
12 x 1.1 mm 101 68 83
12 x 2 mm 101 68 70
14 x 2 mm 101 68 63
15 x 2.5 mm 101 68 85
16 x 1.5 mm 101 68 82
16 x 2 mm 101 68 74
17 x 2 mm 101 68 76
18 x 2 mm 101 68 77
20 x 2 mm 101 68 79

Alternatively, the compression fittings $\frac{3}{4}$ " male connection according to DIN V 3838 (cone "Euro") of other manufacturers may also be used - except for composition pipe "Copipe".

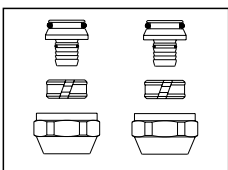

„Cofit S“ for male thread $\frac{3}{4}$ "
according to DIN V 3838 (cone "Euro")
for composition pipe
"Copipe" and, provided similar preparation is used, also for plastic pipes (PE-X pipes), 2-fold, metal to metal sealing plus O-ring, outlet made of brass resistant to dezincification, compression ring and collar nut made of brass, collar nut nickel plated
14 x 2 mm x $\frac{3}{4}$ " collar nut 150 79 34
16 x 2 mm x $\frac{3}{4}$ " collar nut 150 79 35
18 x 2 mm x $\frac{3}{4}$ " collar nut 150 79 38
20 x 2 mm x $\frac{3}{4}$ " collar nut 150 79 39
20 x 2.5 mm x $\frac{3}{4}$ " collar nut 150 79 40

For filling and draining the radiators via the isolating fittings:
101 62 41, 101 62 42, 101 63 41/42, 101 62 91, 101 62 92,
101 63 91/92, 101 61 55/65, 101 65 55/65, 101 61 74/76,
101 65 74/76, 101 59 93/94, 101 59 33/34, 101 59 43/44,
101 59 23/24, 101 61 75/77, 101 65 75/77, 101 61 66/68,
101 65 67/69.

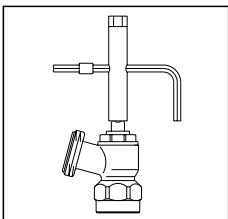

Service tool
with bag 109 05 51

Connection programme "Multiflex F" with soft seal

Cut illustrations of two pipe fittings ZBU and CEW:

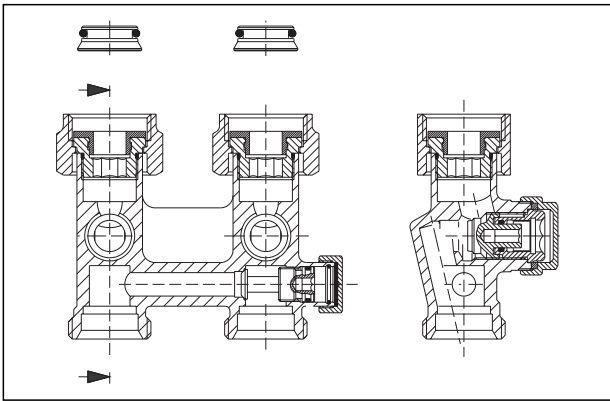

ZBU preset isolating fitting for two pipe systems for filling and draining, item no. 101 59 43

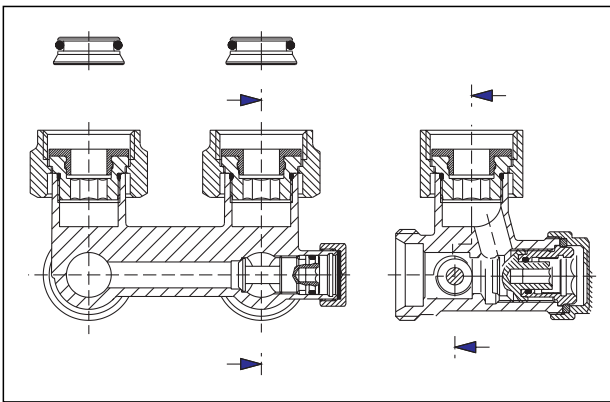

ZBU angle pattern preset isolating fitting for two pipe systems for filling and draining, item no. 101 59 44

The bypass stem of the CEW fitting is opened according to the radiator share (35%).

Operating instructions:

For ZBU/CEW isolating fittings for filling, draining and presetting, item nos. 101 59 43/44 ZBU
101 59 93/94 ZBU
101 59 33/34 CEW
101 59 23/24 CEW

For single fittings, item nos. 101 61 66/68
101 65 67/69
101 61 75/77
101 65 75/77

1 Isolating:

- 1.1 Remove protection caps.
- 1.2 Close valve disc by turning a 4 mm spanner clockwise.

2 Draining:

- 2.1 Isolate the fitting as described under point 1.
- 2.2 Loosen the valve insert of the return pipe connection by turning a 10 mm spanner anticlockwise (max. ¼ turn of thread).
- 2.3 Fit the service tool to the return pipe connection and connect a ½" hose.
- 2.4 Fit the 10 mm spanner to the service tool and drain the radiator by turning anticlockwise.
The venting screw at the radiator has to be opened.

3 Filling:

- 3.1 via the service tool:
 - 3.1.1 If the radiator was just drained by use of the service tool, no modifications to the tool or the fitting are required. The radiator can now be filled by means of the ½" hose (radiator now has to be bled).
 - 3.1.2 With the filling operation completed, fit the 10 mm spanner to the service tool again and close the insert by turning clockwise.
 - 3.1.3 Remove the service tool and tighten the insert by means of the 10 mm spanner (max. 10 Nm).

3.2 via the heating system:

- 3.2.1 Open the valve disc by turning a 4 mm spanner anticlockwise until stop. Bleed radiator.
- 3.2.2 Replace protection caps.

Filling and draining of the radiator by use of the service tool item no. 109 05 51.

4 Presetting:

- 4.1 Unscrew protection cap.
- 4.2 Close the valve disc by turning a 4 mm clockwise.
- 4.3 Then preset the valve disc by turning the 4 mm spanner anticlockwise according to the number of turns selected from the flow chart.

Connection programme "Multiflex V"
with metal to metal seal

CE fitting
Item nos. 101 63 11/12
101 63 81/82

Item nos. 101 63 41/42
101 63 91/92

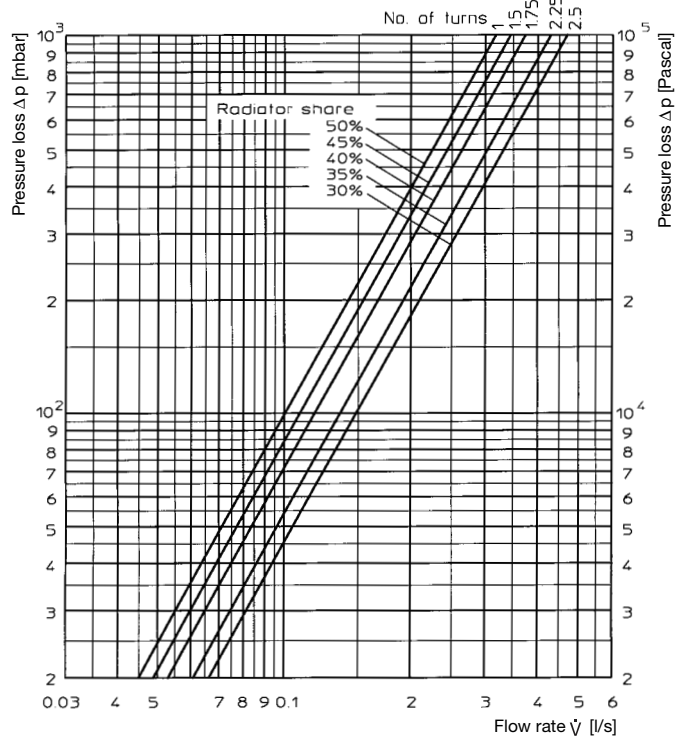
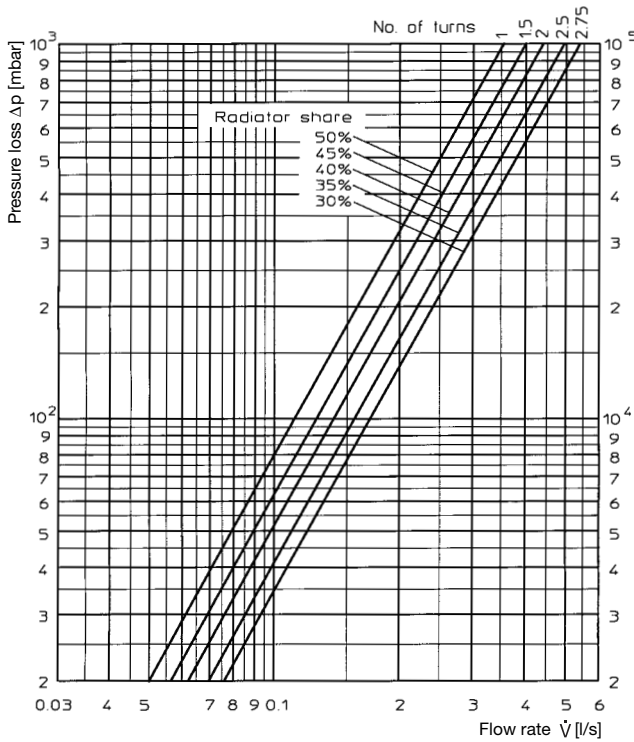

ZB-fittings
Item nos. 101 62 12/41/42
101 62 82/91/92

Single fittings
Item nos. 101 61 04/06 101 61 55/65 101 65 55
101 61 86 101 61 76 101 65 74/76

Presetting	0.25	0.5	0.75	1	1,5	2	3	4
kv value	0.060	0.126	0.190	0.250	0.420	0.819	1.236	1.700

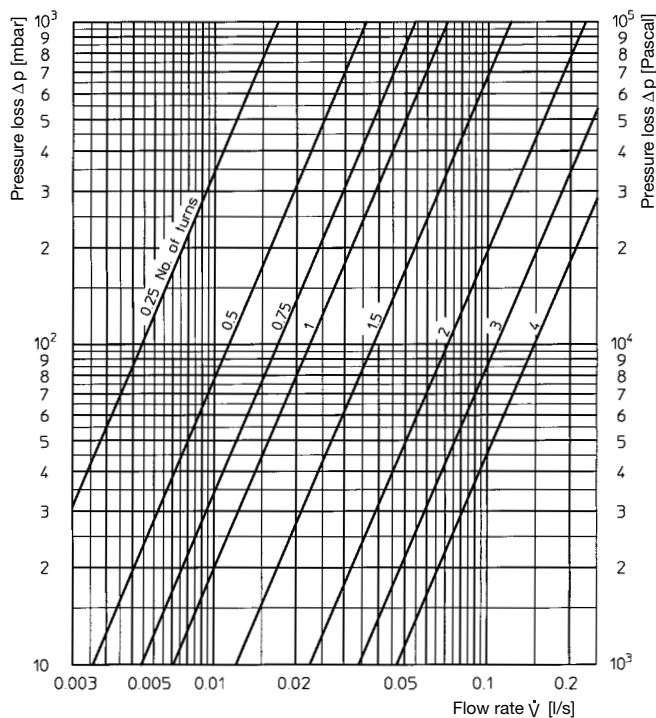

Connection programme "Multiflex F" with soft seal

ZBU and CEW fitting in one pipe operation

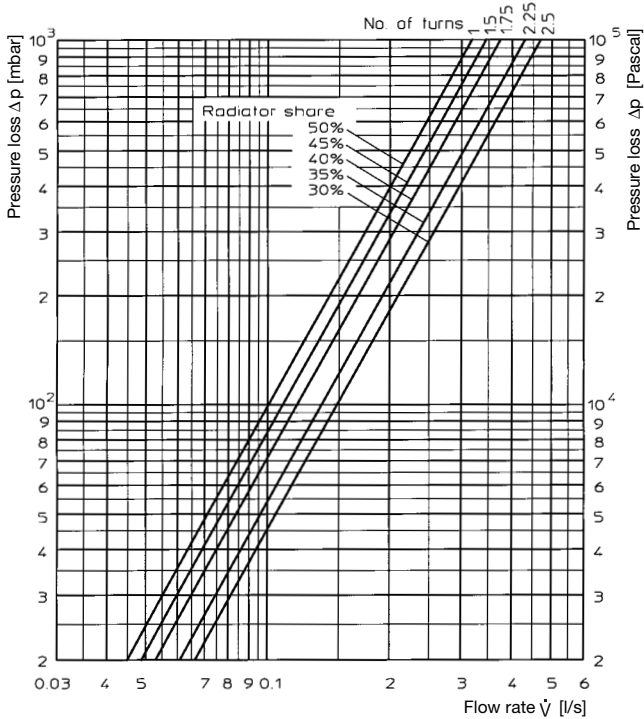

ZBU fitting and single fitting in two pipe operation:

Presett.	0.25	0.5	0.75	1	1,5	2	3	4
kv value	0.060	0.126	0.190	0.250	0.420	0.819	1.236	1.700

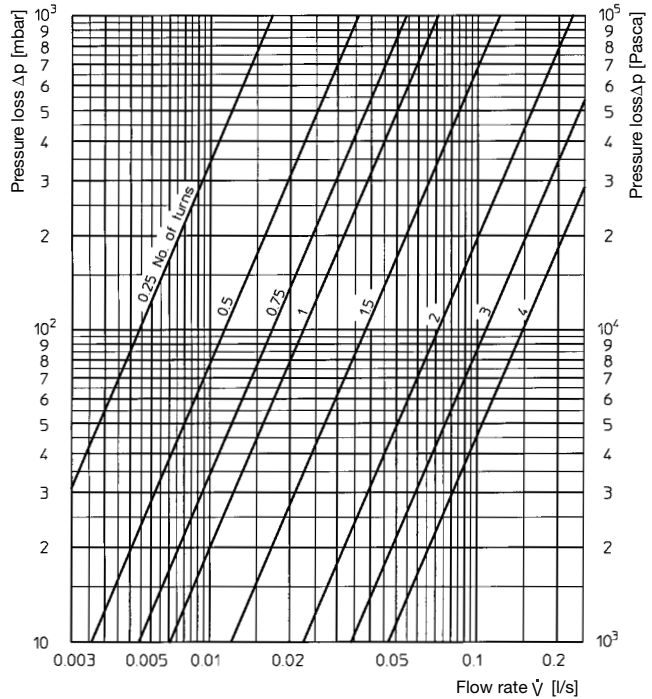

Connection programme "Multiflex"

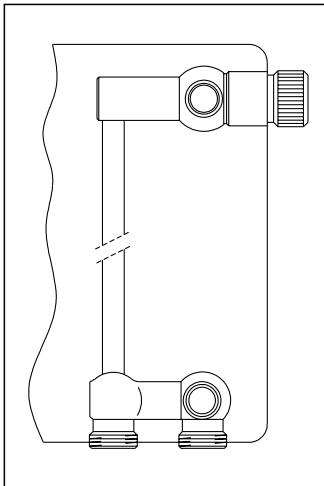

Radiator manufacturers:

- Baufa
 - Brötje
 - Brugman
 - Buderus
 - De 'Longhi
 - Kermi
 - Ribe
 - Vogel + Noot
- (subject to change without notice)

Radiator with integrated distributor
3/4" male thread, distance between pipe centres 50 mm

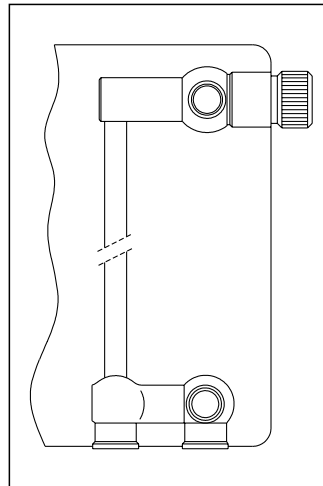

Radiator manufacturers:

- Agis, Alarko, Arbonia, Baykan,
 - Bemm, Biasi, Borer, Bremo,
 - Caradon-Stelrad, Celikpan,
 - Concept, Cöskünöz, DEF,
 - Delta, Demrad, DiaNorm, Dia-
 - therm, Dunafer, DURA, Ferroli,
 - HM-Galant, Henrad, Hoval,
 - Hudevad, IMAS, Itemar,
 - Korado, Manaut, Quinn, Purmo,
 - Radson, Runtal, Schäfer,
 - Starpan, Stelrad, Superia,
 - TermoTeknik, Thor, US-Steel,
 - Vasco, VEHA, Zehnder, Zenith
- (subject to change without notice).

Radiator with integrated distributor
1/2" female thread, distance between pipe centres 50 mm

Subject to technical modification without notice.

Product range 1
ti 107-1/10/MW
Edition 2008

F. W. OVENTROP GmbH & Co. KG
Paul-Oventrop-Straße 1
D-59939 Olsberg
Telephone (02962) 82-0
Telefax (02962) 82-450
Internet www.orientrop.de
E-Mail mail@orientrop.de

For an overview of our global presence visit www.orientrop.de.